

The Art of Measuring.

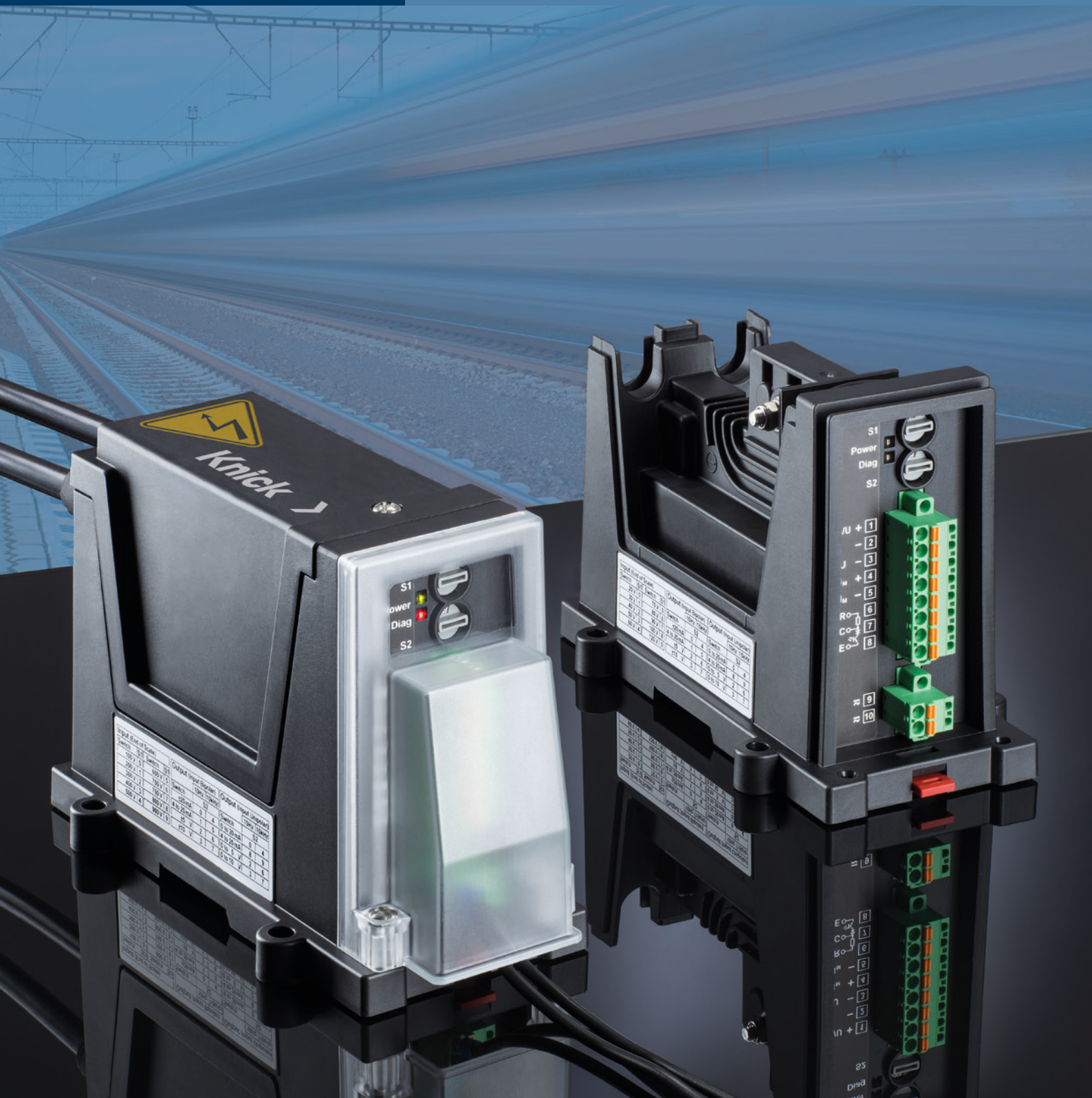

Flexible Transducers
for High Voltage and
Current Measurement
in Railway Applications

ProLine P 50000



ProLine P 50000



Maximum flexibility is achieved through a new housing concept — specifically designed for rolling stock. With integrated broad-range power supply and a unique combination of safety functions.

Electric as well as diesel-electric locomotives and multiple units (EMU/ DEMU) require multifold monitoring and control of electric energy. Voltage and current sensors used for this purpose need to meet the special demands posed by railway operations.

Of particular concern are fire and smoke protection, electrical safety, as well as robustness towards extreme environmental conditions, mechanical stress and EMI influences.

The P50000 transducer series was specifically designed for applications on locomotives and multiple units for short circuit recognition, monitoring and control of traction motors and converters, auxiliary converters, accumulator batteries and others. A brand new feature is the flexibility provided by switchable measuring ranges and an integrated broad-range power supply.

Comprehensive certifications and conformity with railway standards make the devices the ideal choice for railway applications.

ProLine P 50000 — at a Glance

- 4800 V AC/DC protection up to PD3, OV3 according to EN 50124-1, UL 347, no partial discharge up to 8 kV
- 16 kV AC test voltage
- Voltage measurement up to 4800 V with calibrated switching of measuring ranges
- Overload-protected current measurement via shunt resistor from amps to kiloamps
- Particularly low measurement error < 0.1 % meas.val. + 0.1 % f.s.
- Floating standard-signal output, switchable:
0/4 ... (±) 20 mA, 0 ... (±) 10 V, optionally 0/4 ... (±) 10 V, and additional monitoring output
- Integrated broad-range power supply (16.8) 24 ... 230 (253) V AC/DC
Stable during power failure to EN 50155 (S2) and RIA 12-1984
- Distortion-free signal conversion thanks to 3-port isolation between input, output, and power supply
- Fire protection:
HL3 according to EN 45545-2
- Suited for use on railway vehicles:
EN 50125-1/-2 and EN 50155
- Suited for use in substations for traction power supply: EN 50123-1
- Protective covers protect against contact and pollution.
IP rating: IP54 (input) and IP51 (output)
- Diagnostics contact for device status, MTBF up to 155 years
- Resistant against vibration and mechanical shock to EN 61373 (railway applications)
- EMC to EN 50121-1, EN 50121-3-2 (railway applications) and EN 61326-1 (industrial applications)
- Temperature class TX to EN 50155-1 (–40 ... +85 °C)
- Altitude class AX to EN 50155-1, EN 50155-2 (up to 4000 m AMSL)
- Safety ensured by monitoring the input/output circuits and the device status (diagnostics contact)
- Suited for energy measurement to EN 50463-2 (voltage sensor: 0.5 R and current sensor 0.5 R)
- Isolation coordination to EN 50124-1, EN 50123-1 (railway), and EN 50178, UL 347 (industry)
- Wall or DIN-rail mounting
- Mechanically stable HV connection for wires up to 16 mm² (M5 studs)
- Easy installation with push-in terminals for output and power supply (up to 2.5 mm² wires)

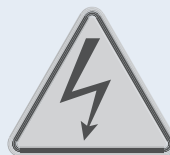

Transducers for High Voltage and Current Measurement in Railway Applications



Mechanically stable HV connection



Protective covers protect against contact and pollution: IP54 (input) and IP51 (output)

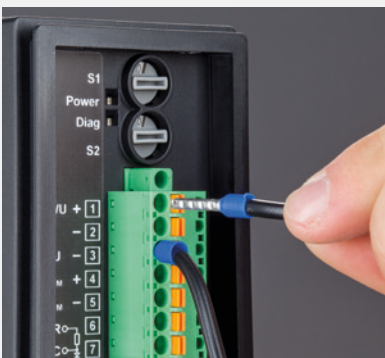

Standard wiring with push-in terminals for output / power supply



LED indicates status of diagnostics contact



Input ranges and floating standard-signal output selectable

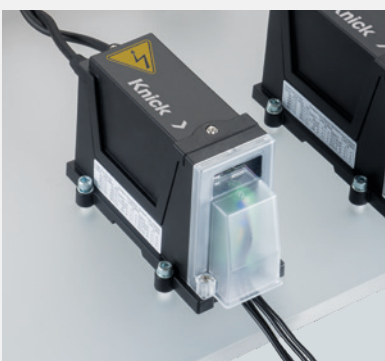

Screw mounting on (conductive or non-conductive) base plate or wall



Variable support sleeves for high-voltage cables up to 16 mm²

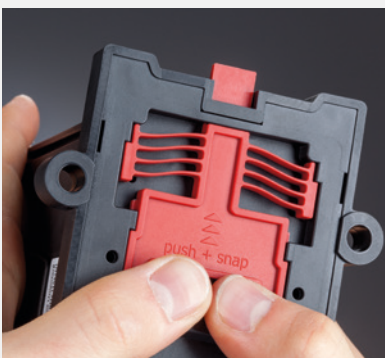

DIN rail mounting using push & snap technology

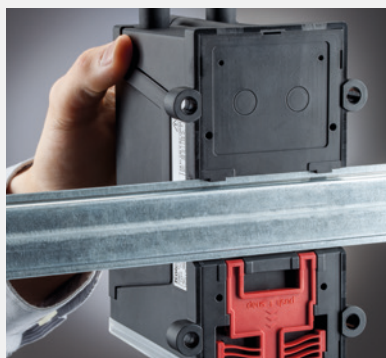

Product Range**ProLine P 50000 Standard Models**

Basic/reinforced insulation 2000/1000 V, input ranges:

Order No.

(±) 30, 50, 60, 90, 100 mV (with or without shunt monitoring)	P51 0 0 0 K 1 1- M 1 M /1 1
(±) 120, 150, 180, 250, 300 mV (with or without shunt monitoring)	P51 0 0 0 K 1 1- M 2 M /1 1
(±) 2, 3, 4, 5, 6, 7, 8, 9, 10, 20 V	P51 0 0 0 K 1 1- M 3 M /1 1
(±) 20, 30, 40, 50, 60, 70, 80, 90, 100, 120 V	P51 0 0 0 K 1 1- M 4 M /1 1
(±) 100, 200, 300, 400, 500, 600, 700, 750, 800, 900	P52 0 0 0 K 1 1- M 5 M /1 1

Basic/reinforced insulation 4800/3600 V, input ranges:

Order No.

(±) 30, 50, 60, 90, 100 mV (with or without shunt monitoring)	P51 1 0 0 K 1 1- M 1 M /1 1
(±) 120, 150, 180, 250, 300 mV (with or without shunt monitoring)	P51 1 0 0 K 1 1- M 2 M /1 1
(±) 2, 3, 4, 5, 6, 7, 8, 9, 10, 20 V	P51 1 0 0 K 1 1- M 3 M /1 1
(±) 20, 30, 40, 50, 60, 70, 80, 90, 100, 120 V	P51 1 0 0 K 1 1- M 4 M /1 1
(±) 100, 200, 300, 400, 500, 600, 700, 750, 800, 900	P52 1 0 0 K 1 1- M 5 M /1 1
(±) 900, 1000, 1200, 1500, 1800, 2000, 2500, 3000, 3600, 4200 V	P52 1 0 0 K 1 1- M 6 M /1 1

Input ranges unipolar/bipolar, U/I output, unipolar/bipolar, live/dead zero, cutoff frequency (10/15 kHz, 10 Hz), all selectable, 24 ... 230 V AC/DC power supply, with diagnostics and protective covers

Transducers for High Voltage and Current Measurement in Railway Applications

Product Range

ProLine P50000 Order Matrix	Order No.	P5			0	0	K		1-			/		
Input 30 mV ... 125 V (current measurement via shunt resistor)		1												
Input 100 ... 4200 V (voltage measurement)		2												
Basic/reinforced insulation 2000/1000 V			0											
Basic/reinforced insulation 4800/3600 V			1											
Without protective covers for input/output terminals								0						
With protective covers for input/output terminals								1						
Power supply output terminals: push-in spring cage terminals									1-					
Multi-range models: up to 10 input ranges ¹⁾ (5 input ranges with/without shunt monitoring)										M	nnnnn			
Fixed-range model: 1 bipolar input range ²⁾ , full scale value xxxxM [mV] or xxxxV [V], resp.										B	xxxxX			
Fixed-range model: 1 unipolar input range ²⁾ , full scale value xxxxM [mV] or xxxxV [V], resp.										U	xxxxX			
Fixed-range model: 1 bipolar input range for energy measurement ³⁾ to EN 50463, full scale value xxxxM [mV] or xxxxV [V], resp.										E	xxxxX			
U/I output and cutoff frequency switchable ⁴⁾												M		
Output 0 ... 20 mA ⁵⁾												A		
Output 4 ... 20 mA ⁵⁾												B		
Output 0 ... 10 V ⁵⁾												C		
Output 0 ... 5 V ⁵⁾												D		
Output ±20 mA ⁵⁾												E		
Output ±10 V ⁵⁾												F		
Output ±5 V ⁵⁾												G		
Output (±) 0/4 ... 40 mA / 250 Ω and cutoff frequency switchable (on request) ⁴⁾												H		
Different output range												S		
Without diagnostics function													0	
With diagnostics function													1	
Power supply 24 V DC														0
Power supply 24 ... 230 V AC/DC														1

¹⁾ Input ranges freely selectable within the following limits
 ProLine P51000/P51100: (±) 30 mV ... 300 mV (with/without shunt monitoring) or 200 mV ... 12.5 V or 2 V ... 125 V
 ProLine P52000: (±) 100 ... 900 V or 750 ... 1800 V
 ProLine P52100: (±) 100 ... 900 V or 750 ... 4200 V

²⁾ Only in combination with fixed output range / fixed-range model without rotary switches

³⁾ Products for energy measurement according to EN 50463 as fixed-range model only, bipolar output range

⁴⁾ Cutoff frequency 14 kHz (P51x00) / 9 kHz (P52x00) and 10 Hz

⁵⁾ Cutoff frequency 14 kHz (P51x00) / 9 kHz (P52x00), different cutoff frequency on request

ProLine P50000 Accessories

P50000 protective covers with screw fixing, one cover each for input (black) and output/power supply (transparent)

P50000 cable support sleeves, 2 pieces

Order No.

ZU 1030

ZU 1031

Specifications

ProLine P51x00 Input

Measuring range limits	30 mV ... 125 V	Linear up to 120 % of range	Measuring Range (\pm)
Overload capacity	± 5 V		30 mV ... 300 mV
	± 80 V		300 mV ... 12.5 V
	± 200 V	Short-time (1 s) ± 300 V	12.5 V ... 125 V
Input resistance	100 k Ω		30 mV ... 200 mV
	70 ... 100 k Ω		200 mV ... 12.5 V
	360 k Ω		12.5 V ... 125 V
Input capacitance	< 3.3 nF		30 mV ... 12.5 V
	< 1 nF		12.5 V ... 125 V

ProLine P52x00 Input

Measuring range limits	ProLine P52100	100 V ... 4200 V	Unipolar/bipolar, linear up to 120 % of range, max. ± 4800 V DC		Measuring Range (\pm)
	ProLine P52000	100 V ... 1800 V	Unipolar/bipolar, linear up to 120 % of range, max. ± 2000 V DC		
Overload capacity		± 1350 V	Short-time (1 s)	± 2700 V	100 ... 900 V
	ProLine P 52000 Models	± 2000 V	Short-time (1 s)	± 3400 V	750 ... 1800 V
	ProLine P 52100 Models	± 4800 V	Short-time (1 s)	± 7100 V	750 ... 4200 V
Input resistance		> 2 M Ω			100 ... 900 V
		10 M Ω			900 ... 4200 V
Input capacitance		< 10 pF			100 V ... 4200 V

Output

Current output	± 20 mA	Linear up to ± 24 mA ¹⁾	Max. ± 30 mA	
	0(4) ... 20 mA	Linear up to 24 mA ¹⁾	Max. ± 30 mA	
	± 40 mA	Linear up to ± 42 mA	Max. ± 48 mA	(optional)
	0(4) ... 40 mA	Linear up to 42 mA	Max. ± 48 mA	(optional)
Burden	(\pm) 0(4) ... 20 mA	600 Ω	Linear up to 12.6 V	
	(\pm) 40 mA	250 Ω	Linear up to 10 V	
Ripple		10 μ A _{rms}		
Voltage output	± 10 V	Linear up to ± 12 V	Max. ± 15 V	
	0 ... 10 V	Linear up to 12 V	Max. 15 V	
	± 5 V	Linear up to ± 6.5 V	Max. ± 15 V	
	0 ... 5 V	Linear up to 6.5 V	Max. 15 V	
Burden		Min. 1 k Ω	Short-circuit-proof	Short-circuit current < 70 mA
Ripple		2.5 mV _{rms}		

¹⁾ Burden 500 Ω max., with 600 Ω burden: linear up to ± 21 mA, for P52000 with product option E (energy measurement): linear up to ± 26 mA

Monitor Output

Uninterrupted monitoring of the output current (e.g. using multimeter) or connection of a floating local indicator
An open circuit in the monitor output (e.g., due to a line break) has no impact on the current output.

Max. load	10 Ω	Max. voltage drop	0.3 V
Max. permissible cable length			3 m

Transducers for High Voltage and Current Measurement in Railway Applications

Specifications

Transmission Behavior

Gain error	≤ 0.1 %	of measured value	at 23 °C
Gain error due to temperature	≤ 50 ppm/K	of measured value	Reference temperature 23 °C
Offset voltage (voltage output)	≤ 10 mV		at 23 °C
Offset current (current output)	≤ 20 µA		at 23 °C
Offset drift due to temperature	≤ 50 ppm/K	of full scale output	Reference temperature 23 °C
Energy measurement	Accuracy class to EN 50463-2		
ProLine P51*00K*-E fixed-range models ²⁾	0.5 R	for CMF current measurement function including the Maconic MxxxxHS shunt resistor	
ProLine P52*00K*-E fixed-range models ²⁾	0.5 R		
ProLine P51x00	Cutoff frequency (-3dB)	14 kHz (typical)	
	Response time $T_{90\text{ resp}}$	45 µs	
	Rise time $T_{10-90\text{ rise}}$	25 µs	
ProLine P52x00	Cutoff frequency (-3dB)	9 kHz (typical)	
	Response time $T_{90\text{ resp}}$	60 µs	
	Rise time $T_{10-90\text{ rise}}$	36 µs	
ProLine P51x00 / P52x00	10 Hz	Low-pass filter activatable	
	Response time $T_{90\text{ resp}}$	35 ms	
	Rise time $T_{10-90\text{ rise}}$	35 ms	
(Optional)		5000 Hz	100 Hz
	Response time $T_{90\text{ resp}}$	120 µs	4 ms
	Rise time $T_{10-90\text{ rise}}$	75 µs	4 ms

Common-mode gain

	Typical	Cutoff frequency (filter setting)	Remarks
CMG ³⁾	-150 dB	9/14 kHz	DC
	-90 dB	9/14 kHz	AC 50 Hz
T-CMG ⁴⁾	Voltage output	-80 dB	10 Hz
Input square step: $T_r = 1\ \mu\text{s}$	Current output ⁵⁾	-60 dB	10 Hz

²⁾ Max. burden 400 Ω

³⁾ Common mode gain CMG [dB] = $20 \times \log(U_{\text{Out,com}}/U_{\text{In,com}})$

⁴⁾ Transient common mode gain T-CMG [dB] = $20 \times \log(U_{\text{T-Out,com}}/U_{\text{T-In,com}})$

⁵⁾ With 500 Ω burden

Diagnostic Function

		Error Signal	
Signaling device errors and monitoring the input circuit / shunt monitoring ⁶⁾ (P51x00) via analog output signal	Voltage output	0 ... (±) 5/10V	12.25 ... 14 V
	Current output	0/4 ... (±) 20 mA	24.5 ... 28 mA
			21 ... 28 mA
	Current output (optional)	0 ... (±) 40 mA	41 ... 48 mA
Current output		21 ... 28 mA	Burden 600 Ω max.
Signaling device errors via binary relay contact	Floating semiconductor switch (sourcing output, sinking output) based on EN 61131-2 (PLC), compatible with type 1 digital PLC inputs (among others), connection to sourcing or sinking inputs, connection to high-resistance inputs		
Switching voltage	24 V DC (5 ... 30 V DC)	Contact opens in the event of a fault ⁷⁾	
Switching current	Max. 15 mA	Short-circuit limiting $I < 70\ \text{mA}$	
Voltage drop	Max. 3 V		

⁶⁾ Rated current approx. 20 µA

⁷⁾ The diagnostics output is protected against inverse polarity and short circuits up to 30 V DC. The maximum permissible voltage across current/voltage output and diagnostics output is 50 V. Unused terminals must be potential free.

Specifications

Power Supply

Broad-range power supply	Supply voltage range	24 ... 230 V AC/DC ⁸⁾
	Max. permissible supply voltage	253 V AC/DC
	Lowest limit of AC supply	19.2 V AC
	Lowest limit of DC supply	16.8 V DC acc. to EN 50155
24 V power supply	Supply voltage range	24 V ± 30% (DC)/± 20% (AC)
Broad-range power supply / 24 V power supply	Lowest limit of DC supply – short-time	14.4 V DC / 100 ms acc. to EN 50155, RIA 12 (brownout)
	Short interruptions	max. 10 ms
	Class S2 acc. to EN 50155, with 40 mA output: monitor output bypassed	
	AC frequency	48 ... 440 Hz
	Max. power consumption	2.5 W / 6 VA

⁸⁾ With optional (±) 0/4 ... 40 mA output: power supply 24 ... 120 V AC/DC ± 30 % (DC)/± 20 % (AC)

ProLine P5x100 Isolation

	Across Input and Output/Power Supply	
Test voltage	18 kV AC 16 kV AC	Type test 100 % routine test
Partial discharge extinction voltage	> 8 kV AC	10 pC
Rated isolation voltage EN 50124-1, IEC 62497-1, EN 50123-1, EN 50178, UL 347	Basic insulation Max. 4800 V AC/DC	Overvoltage category OV3, pollution degree PD3 Rated impulse voltage: 33 kV
Rated isolation voltage EN 50124-1, IEC 62497, EN 50178	Protection against electric shock by reinforced insulation Max. 3600 V AC/DC	Overvoltage category OV3, pollution degree PD3 for EN 50178: PD2 Rated impulse voltage: 33 kV
Contact protection (protection against electric shock)	Max. 3600 V AC/DC	With ZU 1030 protective covers, ZU 1031 cable support sleeves acc. to EN 50153 ranges I to III
Clearances	Min. 60 mm	
Creepage distances	Min. 90 mm	CTI 600, insulant group I acc. to EN 50123-1, EN 50124-1

ProLine P5x000 Isolation

	Across Input and Output/Power Supply	
Test voltage	12 kV AC 10 kV AC	Type test 100 % routine test
Partial discharge extinction voltage	> 6 kV AC	10 pC
Rated isolation voltage EN 50124-1, IEC 62497-1, EN 50123-1, EN 50178, UL 347	Basic insulation Max. 2000 V AC/DC	Overvoltage category OV3, pollution degree PD3 Rated impulse voltage: 20 kV
Rated isolation voltage EN 50124-1, IEC 62497, EN 50178	Protection against electric shock by reinforced insulation Max. 1000 V AC/DC	Overvoltage category OV3, pollution degree PD3 for EN 50178: PD2 Rated impulse voltage: 20 kV
Contact protection (protection against electric shock)	Max. 1000 V AC/DC	With ZU 1030 protective covers, ZU 1031 cable support sleeves acc. to EN 50153 ranges I to III
Clearances	Min. 60 mm	
Creepage distances	Min. 90 mm	CTI 600, insulant group I acc. to EN 50123-1, EN 50124-1

Transducers for High Voltage and Current Measurement in Railway Applications

Specifications

Isolation	Across Output and Power Supply	
Test voltage	4 kV	100% routine test / type test
Rated isolation voltage	Protection against electric shock	Protective separation according to EN 61140 by reinforced insulation. Overvoltage category OV3, pollution degree PD3 for EN 50178: PD2
EN 50124-1, IEC 62497, EN 50178, EN 61140 / EN 61010-1, UL347	Max. 300 V AC/DC	Rated impulse voltage: 6.4 kV

Ambient Conditions

Temperature class	TX	EN 50125-1, EN 50155
Operating temperature	-40 ... 85 °C	
Storage temperature	-50 ... 90 °C	
Relative humidity	20 ... 95 % 75 % 95 ... 100 %	Limit values for continuous operation Annual average Occasional
Altitude classes	A1, AX	EN 50125, reduced isolation level for heights of 2000 ... 4000 m AMSL
Air pressure during operation	600 ... 1060 hPa	

Standards and Approvals

Mechanical load	EN 61373 (shock and vibration) Certified by an independent test laboratory (pending)	Category 1, Class B
EMC	EN 50121-1, EN 50121-3-2 (railway applications) EN 61326-1 (product standard) Certified by an independent test laboratory (pending)	
Fire protection	EN 45545-2 (NF F 160-101/-102) Outdoor applications up to HL3 Certified by an independent test laboratory (pending)	
UL	Listing to UL 347, E356768 (pending)	
RoHS conformity	According to directive 2011/65/EU	

Further Data

MTBF	155 / 131 years	40°C / 45°C average ambient temperature, continuous operation, stationary operation in well-kept rooms, no ventilation, EN 61709 (SN 29500) (Deviating MTBF values for operation on rolling stock)
Weight with / without covers	Approx. 780 g / 650 g	
Input protection	High voltage terminals under protective cover, with rubber sleeves over high voltage cables	IP54 acc. to EN 60529
	Without protective covers	IP00
Output protection	Output terminals under protective cover	IP51 acc. to EN 60529
	Without protective covers	IP20
Encapsulation	Electronics completely encapsulated by potting with a silicone-free polyurethane casting resin	
Mounting	On a metallically conductive or non-conductive surface using 4 M6 screws (see dimension drawings for hole pattern) On a 35 mm DIN rail acc. to EN 60715	
Maintenance	The devices are maintenance-free.	
Disposal	At waste management facility in accordance with local regulations	

Schematic Diagram

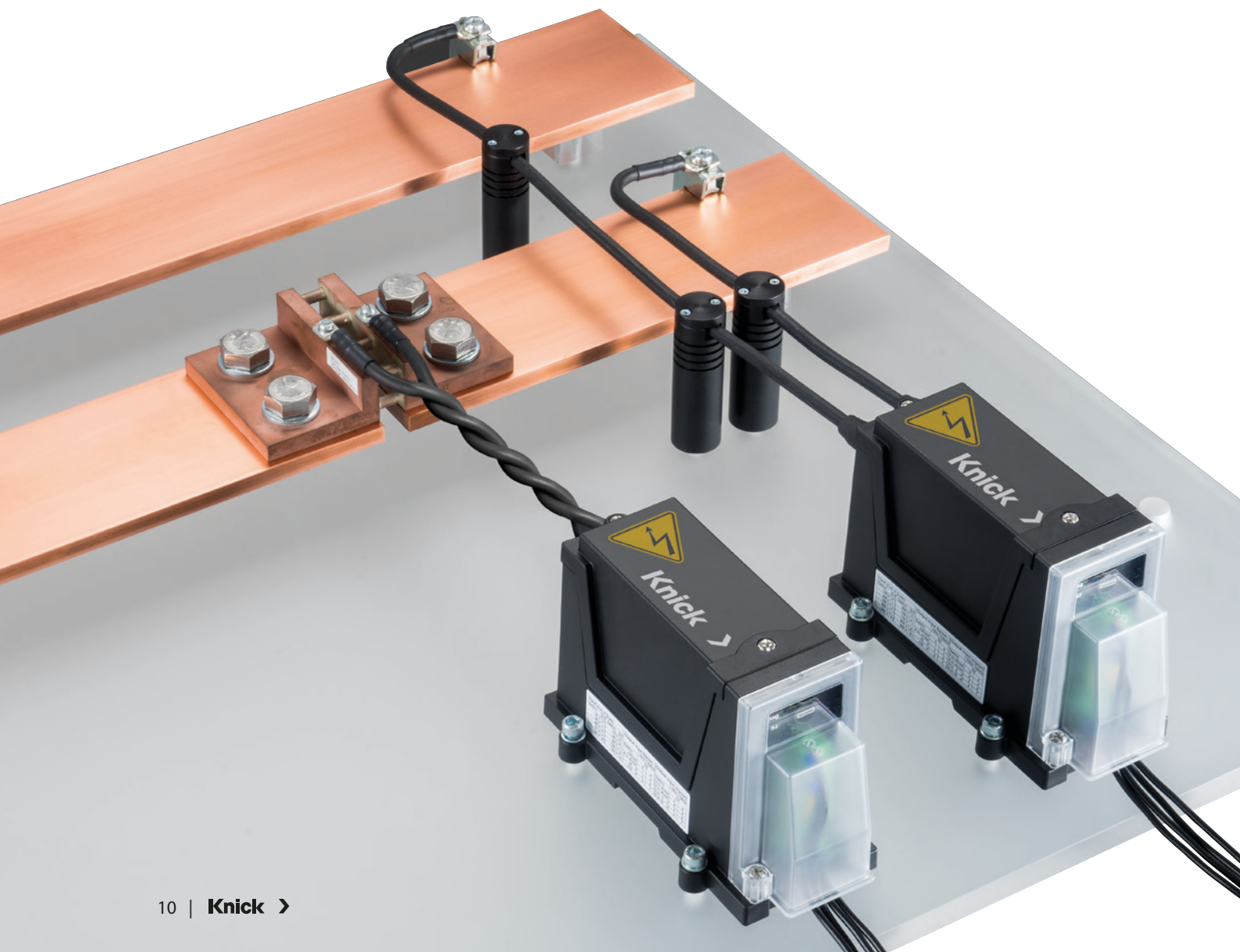
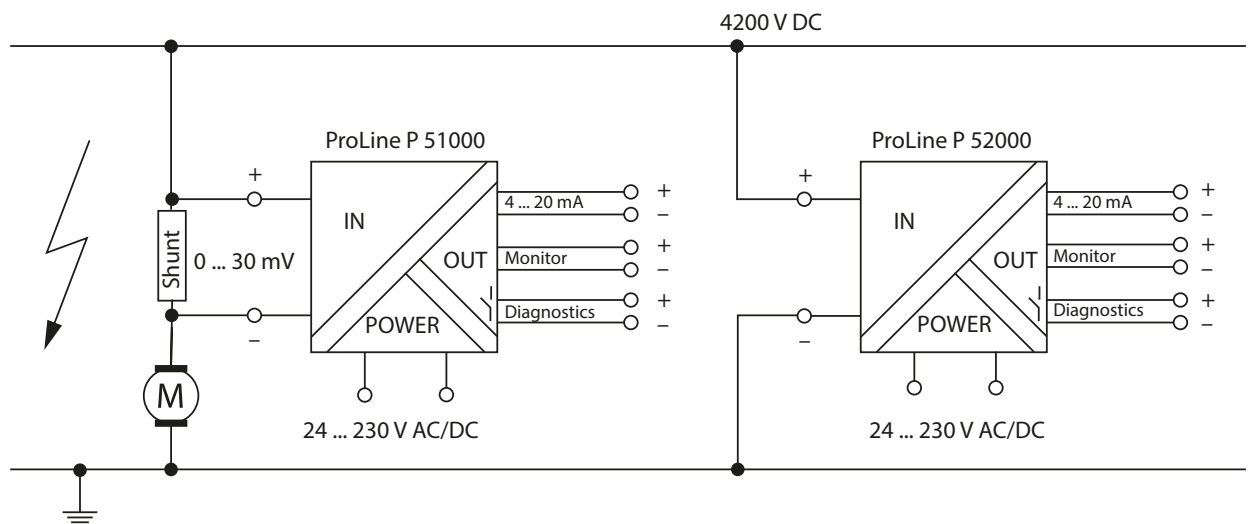

Transducers for High Voltage and Current Measurement in Railway Applications

Terminal Assignments

Type	Signal	Connection
Input	IN +	HV + + input
	IN -	HV - - input
Polarity	⊕ and ⊖ stamps in the housing next to the M5 studs	
Analog outputs "Output"	I + / U +	1 + current/voltage output
	I -	2 - current output
	U -	3 - voltage output
Analog output "Monitor"	I _M +	4 + monitor current output
	I _M -	5 - monitor current output
Binary relay output (floating) "Diagnostics"	R	6 Internal load resistor
	C	7 Relay output: (open) collector
	E	8 Relay output: emitter
Power supply "Power"	≈	9 Power supply 24 ... 230 V AC/DC
	≈	10



Conductor Cross-Section	Min	Max	Unit
Input	1.5	16	mm ² Single cables with M5 ring cable lug
Outputs, power supply	0.25	2.5	mm ² Single cables, solid, flexible, flexible with ferrule (with or without collar)

Note:

- Stripping length or length of the cable ferrule (without collar): 10 mm
- Maximum diameter of the jacket or ferrule collar: 4 mm
- For other diameters: Check if the cables are suitable.

Frequency Response

ProLine P51000 amplitude and phase response (typical)

$U_{OUT_NOM}=10\text{ V}$, $R=1\text{ k}\Omega$, $f_{-3dB}=15\text{ kHz}$

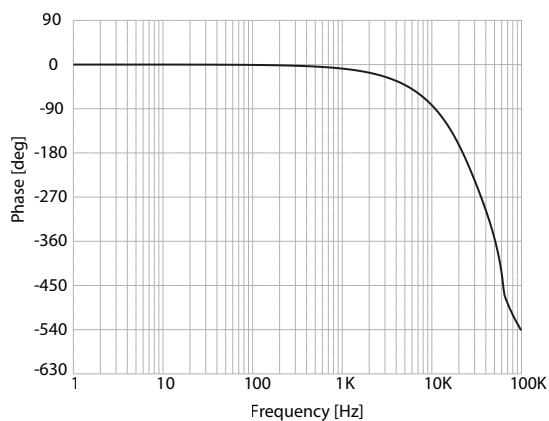
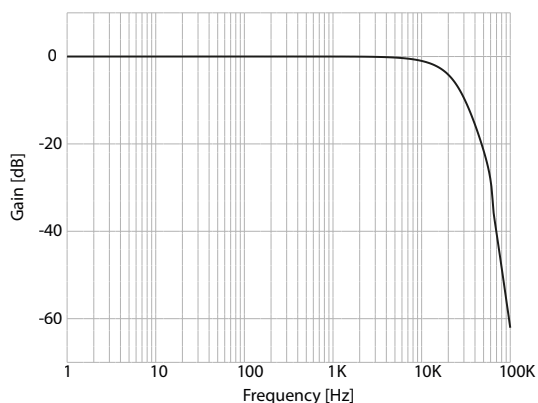

ProLine P52000 amplitude and phase response (typical)

$U_{OUT_NOM}=10\text{ V}$, $R=1\text{ k}\Omega$, $f_{-3dB}=10\text{ kHz}$

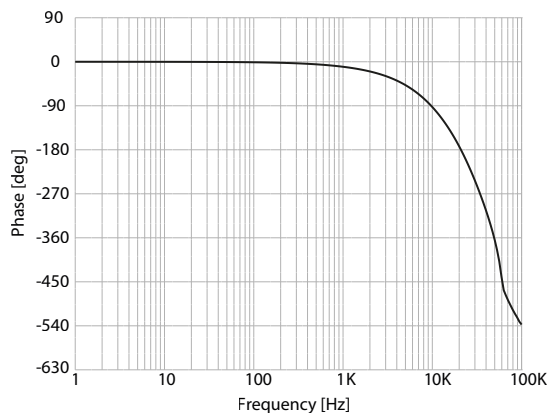
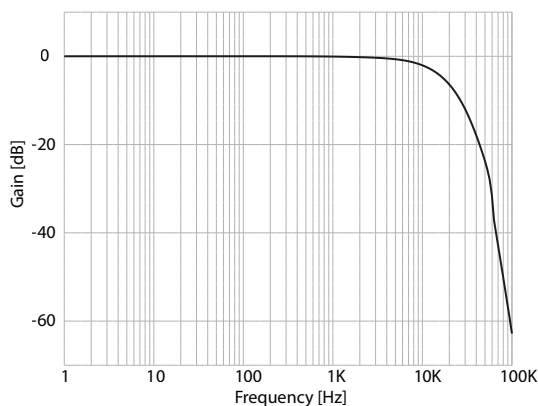

ProLine P51000P52000 amplitude and phase response (typical)

$U_{OUT_NOM}=10\text{ V}$, $R=1\text{ k}\Omega$, $f_{-3dB}=10\text{ Hz}$

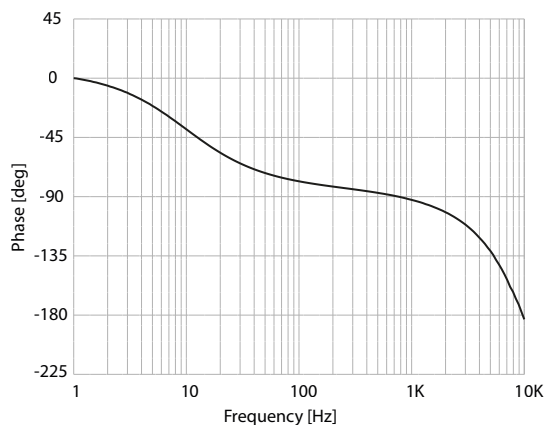
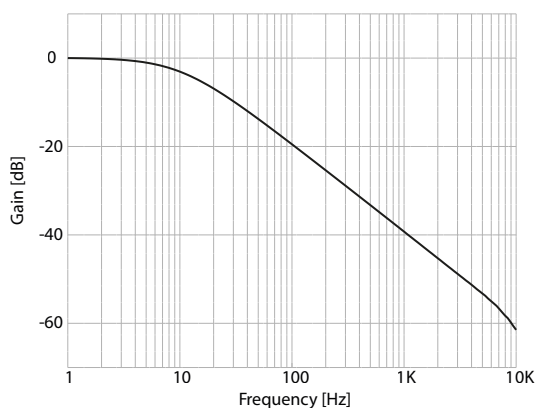

Transducers for High Voltage and Current Measurement in Railway Applications

Common-Mode Behavior

ProLine P51000 common-mode behavior (typical) at 4200 V step with 6 kV/ μ s
 $U_{IN_NOM}=30$ mV, $U_{OUT_NOM}=10$ V, $R=1$ k Ω , $f_{-3dB}=15$ kHz

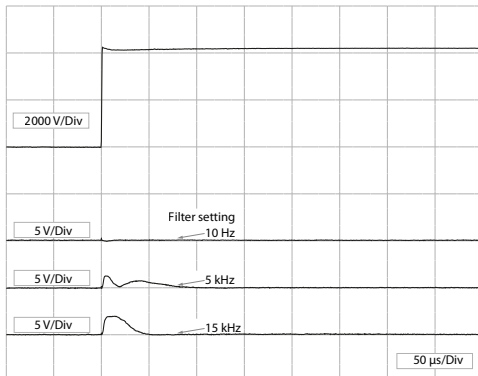

ProLine P52000 common-mode behavior (typical) at 4200 V step with 6 kV/ μ s
 $U_{IN_NOM}=900$ V, $U_{OUT_NOM}=10$ V, $R=1$ k Ω , $f_{-3dB}=10$ kHz

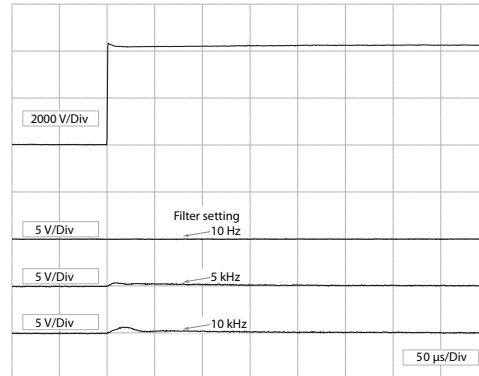

Ripple

ProLine P51000/P52000 ripple (typical)
 $I_{OUT_NOM}=20$ mA, $R=500$ Ω , $f_{-3dB}=10$ kHz/15 kHz

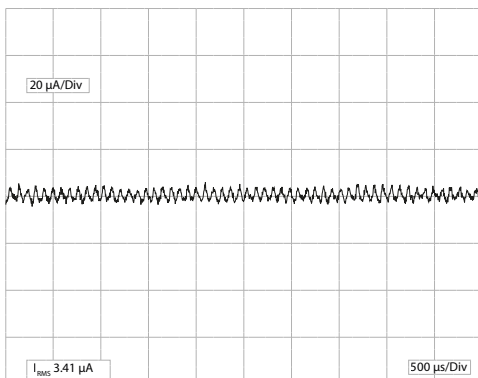

ProLine P51000/P52000 ripple (typical)
 $I_{OUT_NOM}=10$ V, $R=1$ k Ω , $f_{-3dB}=10$ kHz/15 kHz

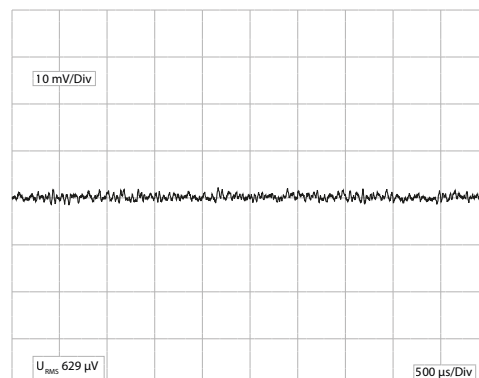

Step Responses

ProLine P51000 step response (typical) 100% step
 $U_{IN_NOM}=1000$ V, $U_{OUT_NOM}=10$ V, $R=1$ k Ω , $f_{-3dB}=15$ kHz

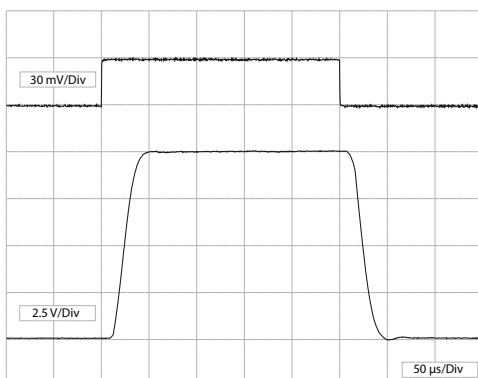

ProLine P52000 step response (typical) 100% step
 $U_{IN_NOM}=1000$ V, $U_{OUT_NOM}=10$ V, $R=1$ k Ω , $f_{-3dB}=10$ kHz

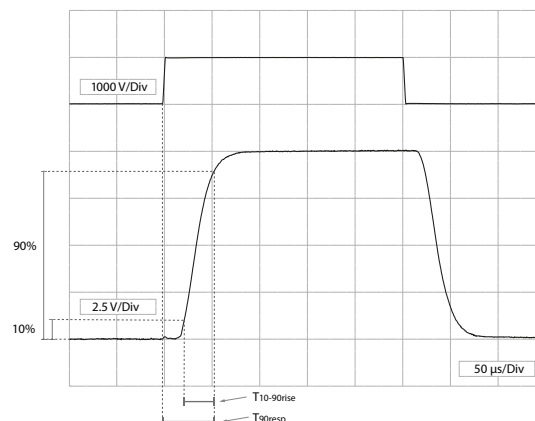

Transmission Curves

Output 0 ... ±10 V, 0 ... ±20 mA

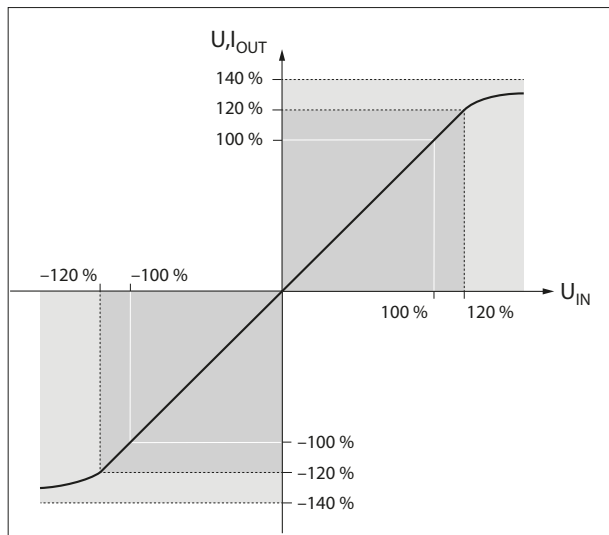

Output 4 ... 20 mA

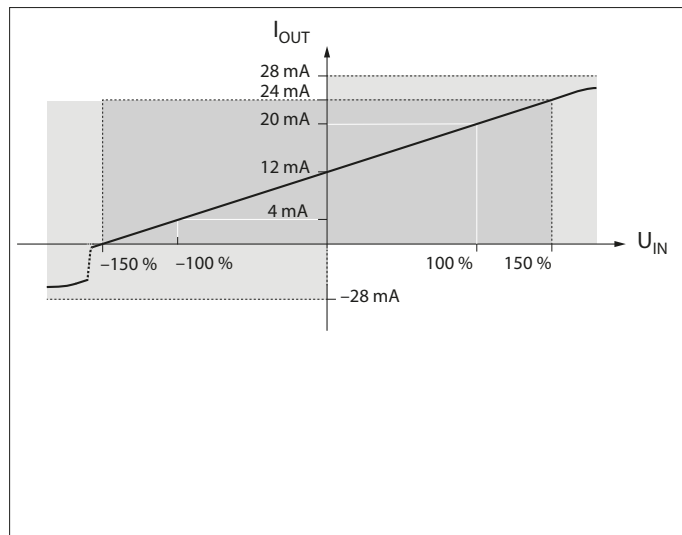

Input unipolar, output 4 ... 20 mA

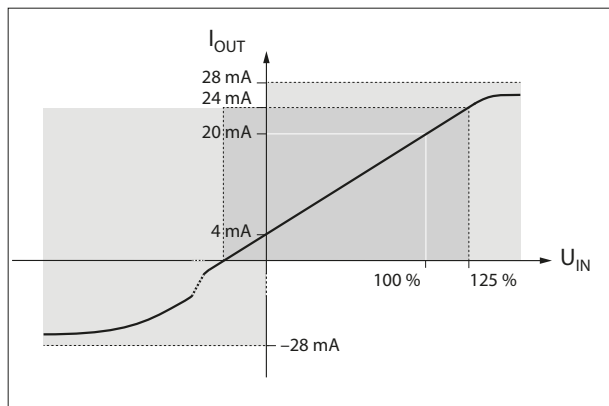

Output 4 ... 40 mA

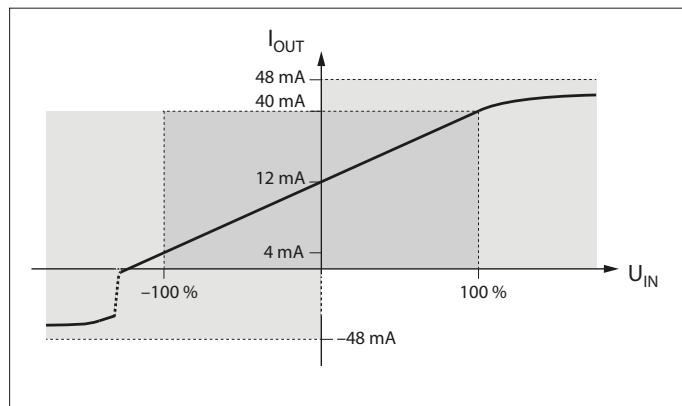

Input unipolar, output 4 ... 40 mA

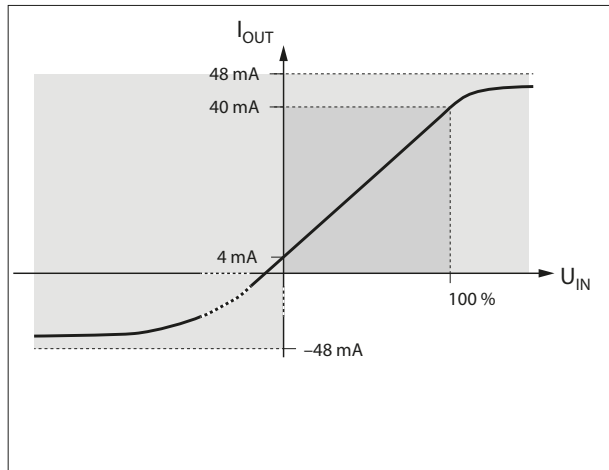

Output 0 ... ±40 mA

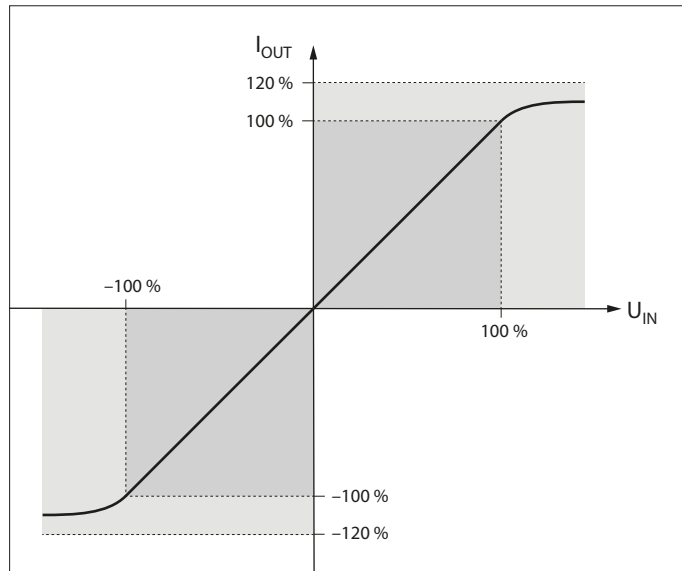

Linear transmission range
 Overdrive region

Transducers for High Voltage and Current Measurement in Railway Applications

Dimension Drawing

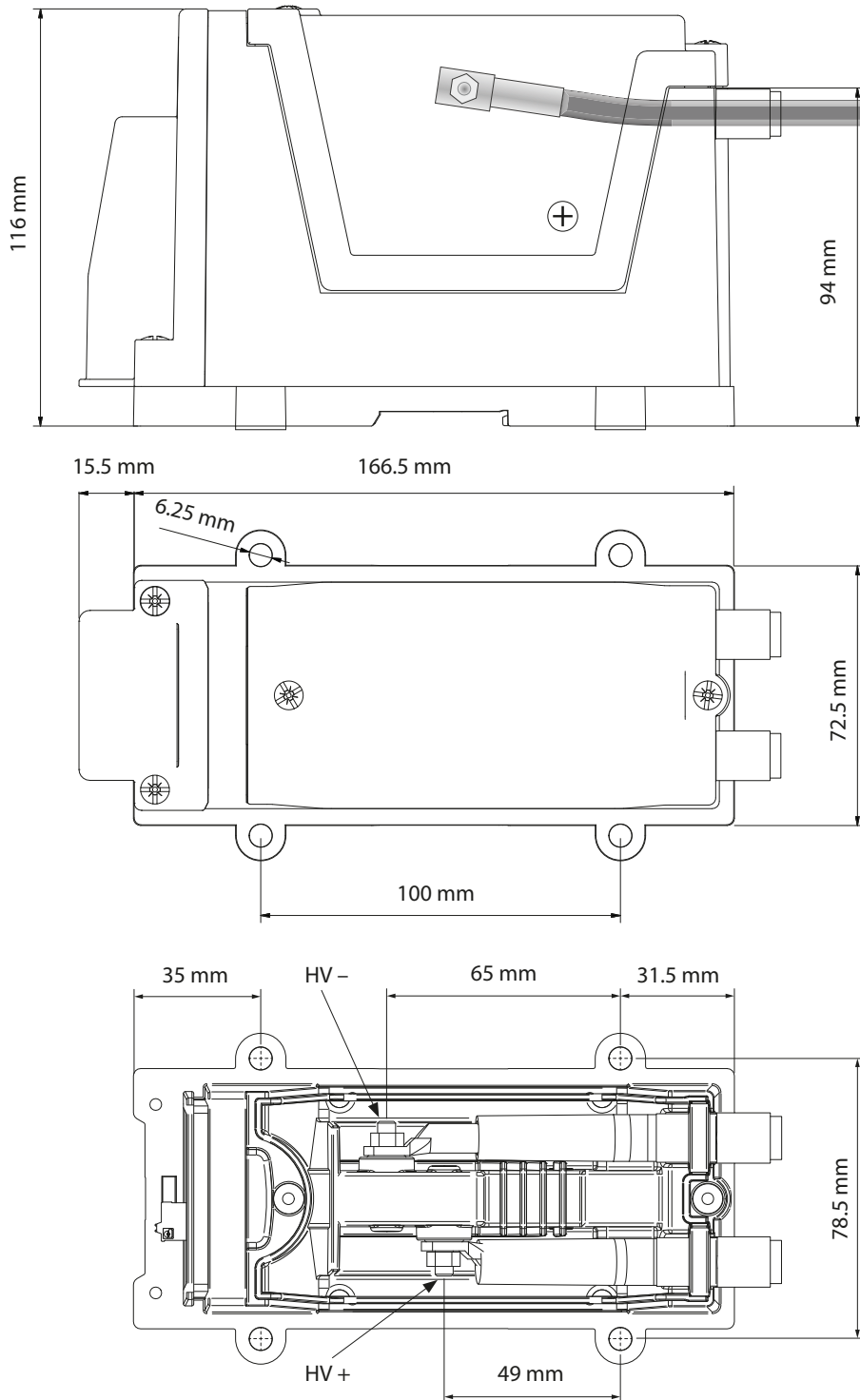



Interface Technology

Indicators
Industrial Transmitters
Portable Meters
Laboratory Meters
Sensors
Fittings

Knick
Elektronische Messgeräte
GmbH & Co. KG

Beuckestraße 22, 14163 Berlin,
Germany
Phone: +49 30 80191-0
Fax: +49 30 80191-200
info@knick.de · www.knick.de